



# Robot Sensors

Henrik I Christensen

Contextual Robotics  
UC San Diego  
La Jolla, CA  
hichristensen@ucsd.edu

## Outline



1 Introduction

2 Sensor Classification

3 Sensors

4 Wrap up

# The Robot Structure

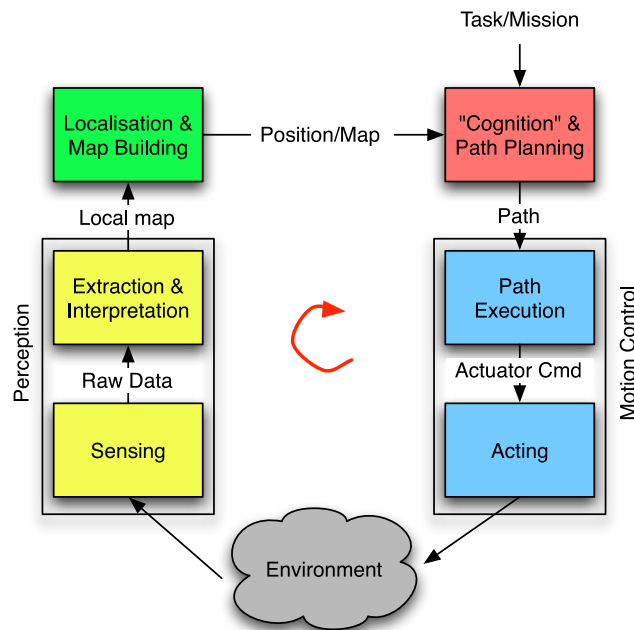

# Robots and Sensors

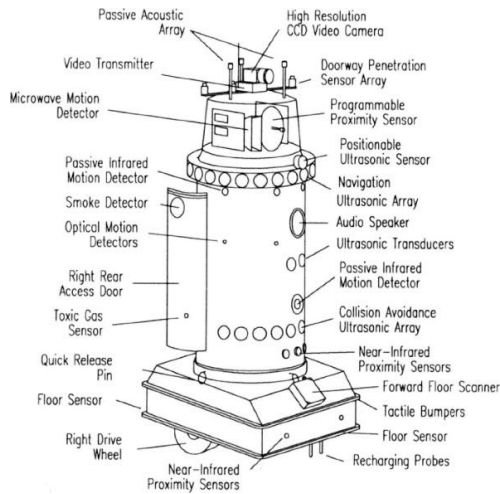
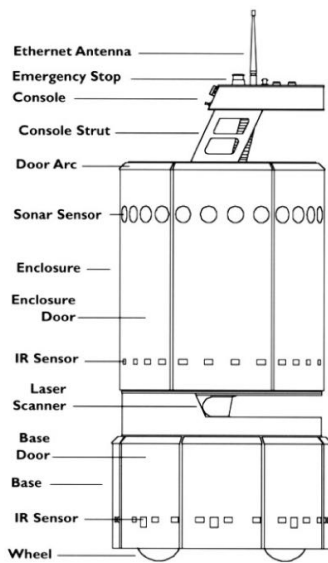

# Robots and Sensors

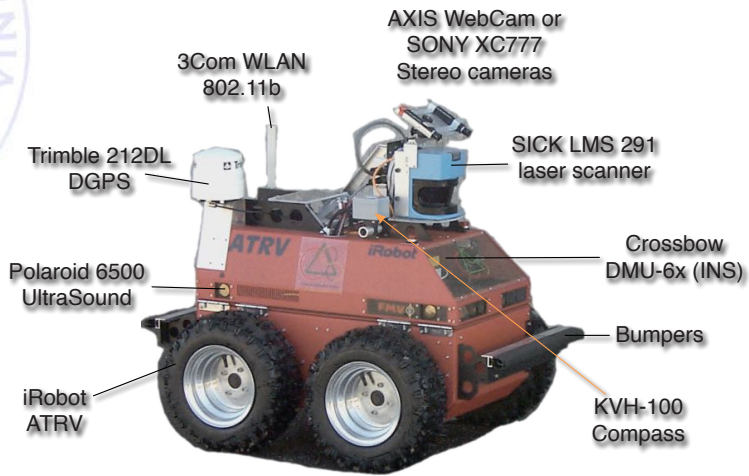

# Robots and Sensors



# Sensors

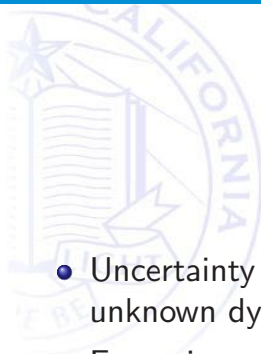

- Uncertainty in the layout of the environment due to lack of models or unknown dynamics
- Execution of commands is uncertain due to imperfect actuation
- Sensors are needed to cope with the uncertainty and provide an estimate of “robot state” and environmental layout.

# Outline



- 1 Introduction
- 2 Sensor Classification
- 3 Sensors
- 4 Wrap up

## Sensor classes

- Sensing is divided according to the purpose:
  - **Proprioception** Estimation of the internal state of the robot. Configuration, temperature, current, speed of axis, ...
  - **Exteroception** Estimation of the state of the environment with respect to robot
- Sensors are also divided according to measurement principle
  - **Passive** Uses ambient energy to perform the measurement
  - **Active** Transmits energy into environment to allow measurements

## Sensors in mobile robotics

Classification	Sensor Type	PC/EC	A/P
Tactile sensors	Switches/Bumpers	EC	P
	Optical barriers	EC	A
	Proximity	EC	P
Haptic sensors	Contact arrays	EC	P
	Force/Torque	EC/PC	P
	Resistive	EC	P
Motor/Axis sensors	Brush Encoders	PC	P
	Potentiometers	PC	P
	Resolvers	PC	A
	Optical encoders	PC	A
	Magnetic encoders	PC	A
	Inductive encoders	PC	A
	Capacity encoders	EC	A

## Sensors for mobile robots

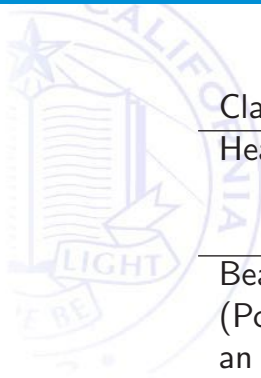

Classification	Sensor Type	PC/EC	A/P
Heading sensors	Compass	EC	P
	Gyroscopes	PC	P
	Inclinometers	EC	A/P
Beacon based (Position wrt an inertial frame)	GPS	EC	A
	Active Optical	EC	A
	RF beacons	EC	A
	Ultrasound beacon	EC	A
	Reflective beacons	EC	A
Ranging	Capacitive sensor	EC	P
	Magnetic sensors	EC	P/A
	Camera	EC	P/A
	Ultra-sound	EC	A
	Laser range	EC	A
	Structures light	EC	A

## Sensors for mobile robots



Classification	Sensor Type	PC/EC	A/P
Speed/motion	Doppler radar	EC	A
	Doppler sound	EC	A
	Camera	EC	P
	Accelerometer	EC	P
Identification	Camera	EC	P
	RFID	EC	A
	Laser ranging	EC	A
	Radar	EC	A
	Ultra-sound	EC	A
	Sound	EC	P

## Sensing types



- **Scalar** Estimation of a scalar / amplitude entity such as temperature, intensity, current, force, ...
- **Position** Estimation of 1D, 2D or 3D position. Typically in  $(x, y)$  or  $(\rho, \theta)$  i.e. Cartesian or Polar
- **Derivatives** Estimation of motion or acceleration

## Characterizing Sensor Performance



- **Dynamic Range**
  - Ratio between upper and lower limits (usually in decibel)
  - Power measurements (1 mW to 20 W)

$$10 \log \frac{20}{0.001} = 43dB$$

- Voltage measurements (1 mV to 20 v)

$$20 \log \frac{20}{0.001} = 86dB$$

- I.e.  $F \log \frac{Max}{Min}$ , where  $F=10$  for power entities and  $F=20$  for no-power entities
- **Range:**
  - Upper limit of measurements

# Characterizing Sensor Performance

- Resolution
  - minimum difference between two values
  - often lower limit = resolution
- Linearity
  - Variation of output as a function of input
  - Ideally  $Y = aX$  implies  $Y = a(X_1 + X_2)$
- Bandwidth/Frequency
  - Speed of response, delay

# Characterizing Sensor Performance

- Sensitivity
  - minimum input change to result in output change
- Cross sensitivity
  - Variation with other changes such as temperature
- Error/accuracy
  - Difference between actual value and generated value

$$accuracy = 1 - \frac{|m - v|}{v}$$

where  $m$  is the measured value and  $v$  is the true value



# Characterizing Sensor Performance

- Most sensors generate measurements that are contaminated by noise.
  - Systematic noise: errors that could be modelled for example through calibration
  - Random noise: errors that cannot be predicted. Typically modelled in a probabilistic fashion
- Precision: reproducibility of measurements

$$precision = \frac{range}{\sigma}$$

## Outline

- 1 Introduction
- 2 Sensor Classification
- 3 Sensors
- 4 Wrap up

# Wheel encoder

- Optical encoders. A disc and a diode. Measurement of discrete values. Quadrature encoders enable detection of direction of motion.

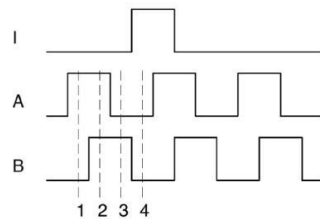
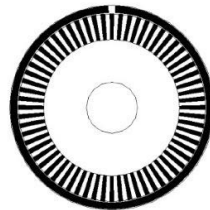

State	Ch A	Ch B
S <sub>1</sub>	High	Low
S <sub>2</sub>	High	High
S <sub>3</sub>	Low	High
S <sub>4</sub>	Low	Low

# Quadrature encoders

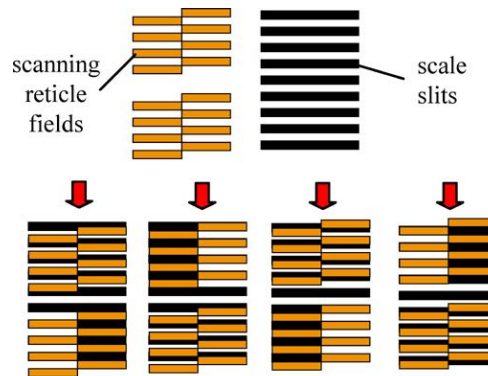
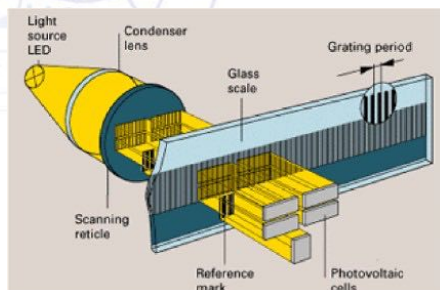

Notice what happen when the direction changes:

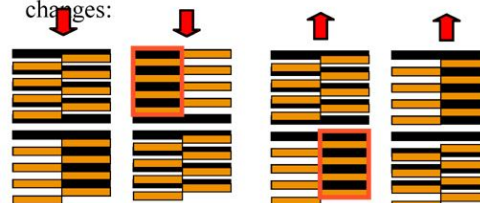

# Greycoded Encoders

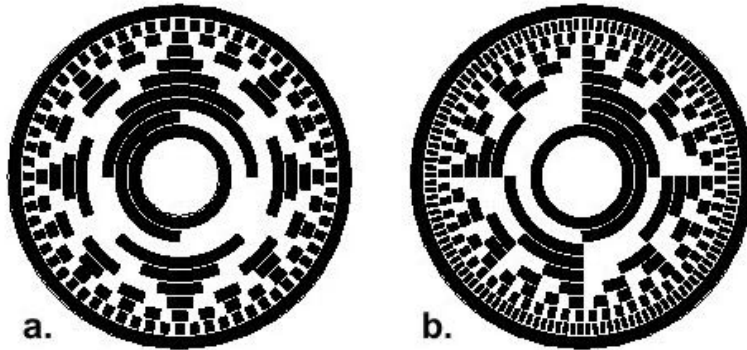

- Rotating an 8-bit absolute Gray code disk.
- a. Counterclockwise rotation by one position increment will cause only one bit to change.
  - b. The same rotation of a binary-coded disk will cause all bits to change in the particular case (255 to 0) illustrated by the reference line at 12 o'clock.
- [Everett, 1995].

# Orientation and heading



- Compass used as a reference since 2000 B.C.
- Today available in solid state technology
- Sensitive to ferro magnetic materials
- High environmental variation



# Gyro/Accelerometers

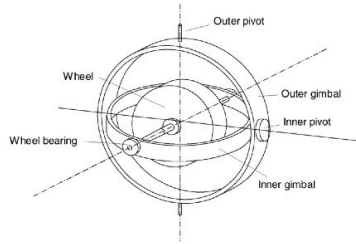

- The inertia of a spinning wheel provides a reference for orientation.
- Today available in fiber-optic and solid state versions
- Double integration implies high noise sensitivity

# Ranging

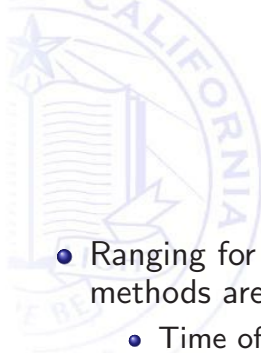

- Ranging for estimation of position is a **very** common methodology. Several methods are used:
  - Time of Flight: Travel time for a pulse
  - Phase Difference: Phase of modulation  $\propto$  time of travel
  - Triangulation: Simple geometric relations
- From range measurements position can be estimated

# Time of Flight – Ranging

- Measures travel time.
- Speed of propagation  $c$ , distance  $d$  implies

$$d = c \times t \Rightarrow t = \frac{d}{c}$$

- Travels back and forth so  $d = \frac{c}{2}t$

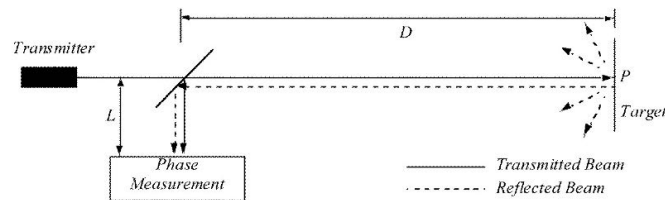

# Phase differencing – Ranging

- At a distance  $D$  the phase difference is

$$\theta = \frac{4\pi D}{\lambda}$$

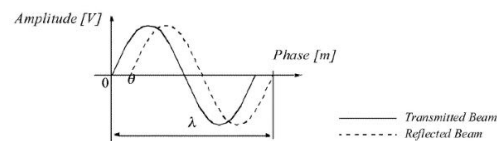

- Estimated using PLL which is “inexpensive” technology

# Triangulation – Ranging

- Use simple geometric relations to recover depth
- Example is IR/Laser triangulation

$$D = f \frac{L}{x}$$

- Depth inversely proportional to  $x$

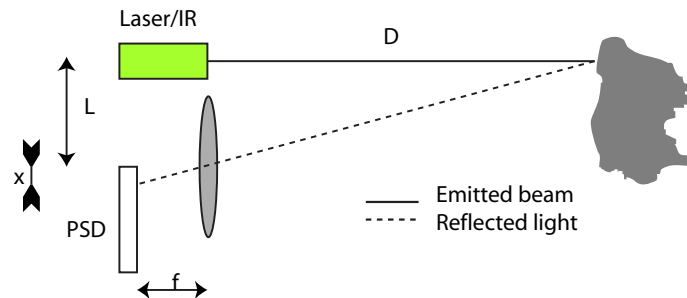

# Sharp Triangulation Sensors

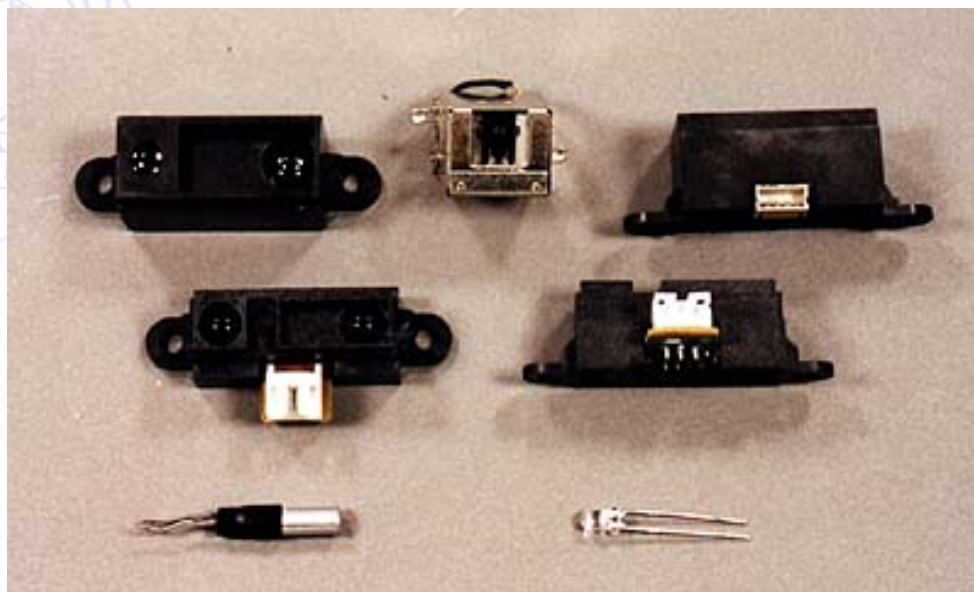

## Position from Range

- One of the most common approaches in robotics
- Consider handling of two range readings

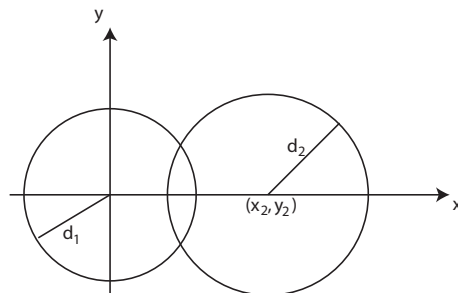

## Position from Range

- Given two range pings  $d_1$ ,  $d_2$  and known positions:  $(0, 0)$  and  $(x_2, y_2)$  the position of intersection is

$$x = \frac{x_2^2 + d_1^2 - d_2^2}{2x_2}$$
$$y^2 = \frac{2x_2^2 d_1^2 + 2d_1^2 d_2^2 + 2x_2^2 d_2^2 - x_2^4 - d_1^4 - d_2^4}{4x_2^2}$$

- Trivial to compute intersection point(s)

## Unique position estimates

- With 3+ range estimates the intersection point is unique
- Noise might contaminate the measurements

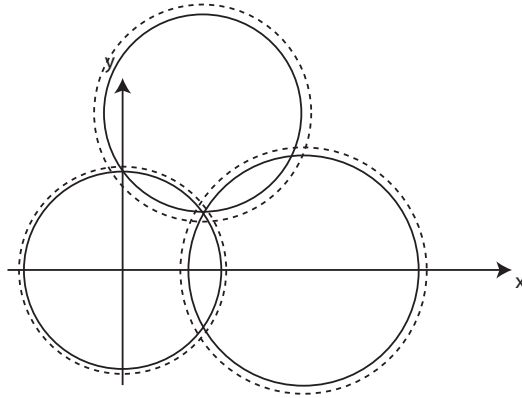

## Ultra-sonic ranging

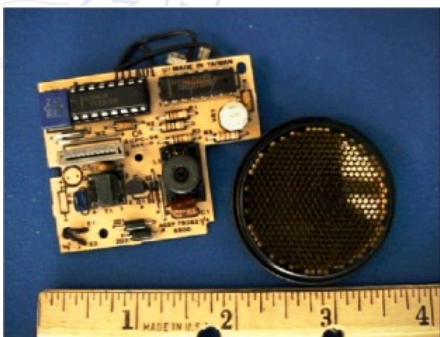

- Widely used in underwater for mapping
- In air the main application has been cameras
- Speed of sound  $\approx 343 \frac{m}{s}$  so processing is “slow”
- Pulse based time of flight (49.1 kHz)
- Cheap technology for mass products



# Sonar ranging

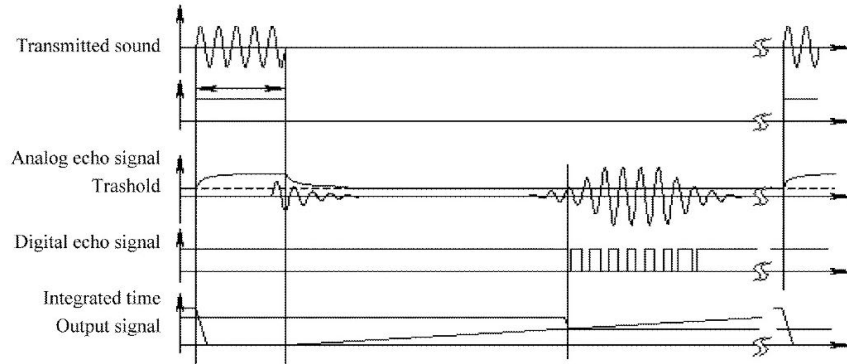
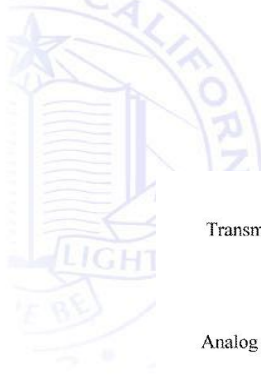

# Sonar sensing – Characteristics

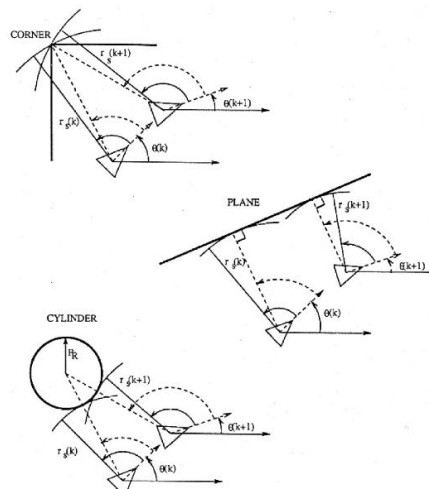
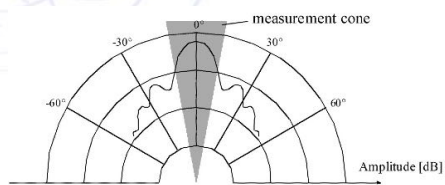

# Underwater Sonar

## Types of underwater imaging sonars

### Mechanical (Imagenex)

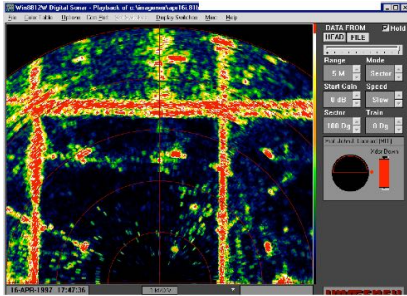

### Electronically-scanned (Reson)

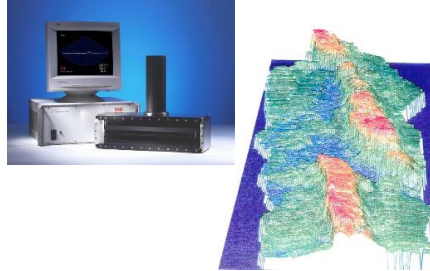

### Acoustic Lens (U.W.)

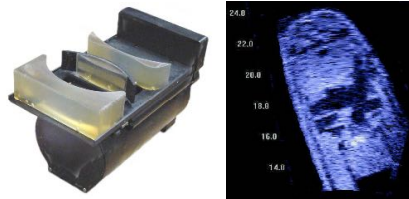

### Side-scan sonar (Klein)

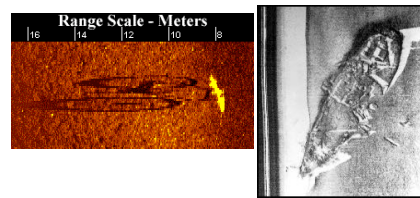

# IR Ranging

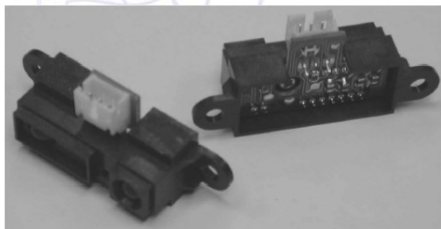

- Short-range triangulation sensor
- Dependent on surface color/reflectance
- Very inexpensive (easy interfacing)
- Primarily obstacle detection

## Laser Scanning - Beacon Based

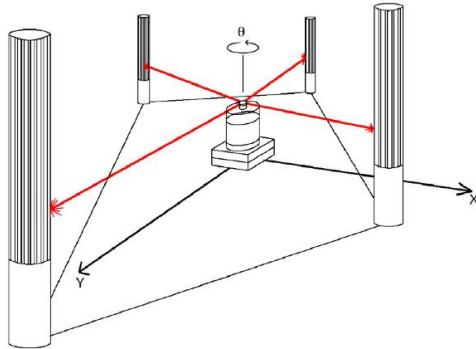

- Angular distribution / Known landmarks
- Robust to variations
- Easy to install
- Used in factory settings for AGV systems
- More than 15000 units sold

## Laser Scanning - TOF



- Rotating mirror
- Pulsed laser
- Range 10-50 m
- Resolution  $\approx 1$  cm
- Sampling rate: 37 Hz

# Laser scanner - SICK

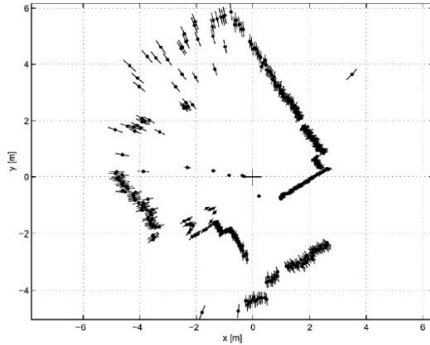

- Frequently used sensor system in the past, not replaced by many other providers
- Safety classified
- Unusual error distribution (uniform)
- Price: \$ 4000

# Modern AMR w. sensors

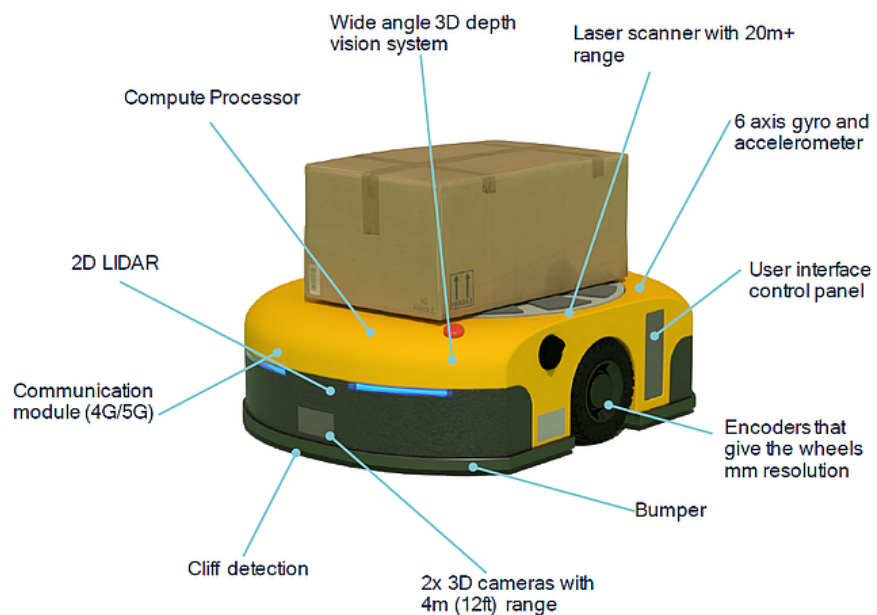

# Outline

- 
- 1 Introduction
  - 2 Sensor Classification
  - 3 Sensors
  - 4 Wrap up

# Summary

- 
- Introduction to classification of sensors for mobile systems
  - Overview of methods for sensing
  - Brief outline of most typical sensors (ex camera / GPS)



# Global Positioning System

Henrik I Christensen

Contextual Robotics  
UC San Diego  
La Jolla, CA  
hichristensen@ucsd.edu

## Outline

- 
- 1 Introduction
  - 2 Position Estimation
  - 3 System Overview
  - 4 Space Segment
  - 5 Control Segment
  - 6 User Segment
  - 7 Augmentation
  - 8 GPS Data
  - 9 WGS
  - 10 Summary

# Global Navigation Satellite System - GNSS

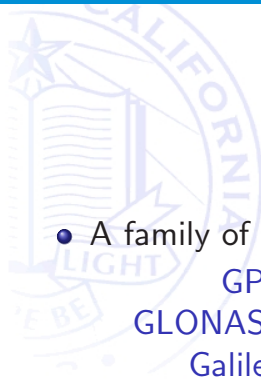

- A family of satellite based systems
  - GPS Global Positioning System
  - GLONASS Russian Equivalent of GPS
  - Galileo EU variation of GPS under construction
  - BeiDou The Chinese variation of GNSS
- Background dates back to radio systems used from 1950.
- GPS is one of the most widely used localization systems today

## Outline

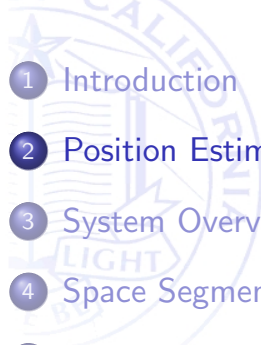

- 1 Introduction
- 2 Position Estimation
- 3 System Overview
- 4 Space Segment
- 5 Control Segment
- 6 User Segment
- 7 Augmentation
- 8 GPS Data
- 9 WGS
- 10 Summary

# Triangulation



- Triangulation discussed earlier is the basis for the design and operation.
- Formally the method is based on trilateration.
- Estimation of a point position based on distance to a number of reference stations. A minimum of 3 references are needed to determine a unique point intersection

# Trilateration

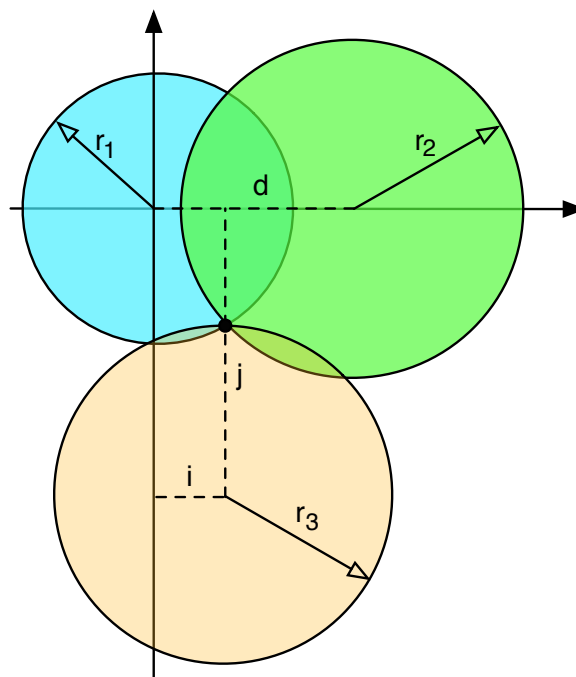



# Trilateration



$$r_1^2 = x^2 + y^2 + z^2 \quad (1)$$

$$r_2^2 = (x - d)^2 + y^2 + z^2 \quad (2)$$

$$r_3^2 = (x - i)^2 + (y - j)^2 + z^2 \quad (3)$$

$\Rightarrow$

$$x = \frac{r_1^2 - r_2^2 + d^2}{2d} \quad (4)$$

$$y = \frac{r_1^2 - r_3^2 + i^2 + j^2 - 2ix}{2j} \quad (5)$$

$$z = \sqrt{r_1^2 - x^2 - y^2} \quad (6)$$

# Trilateration

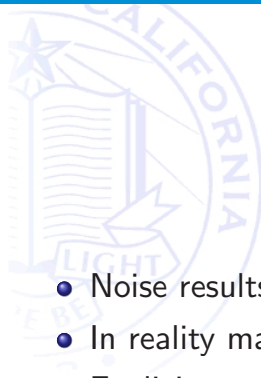

- Noise results in poor stability
- In reality many more references are **often** available
- Explicit consideration of accuracy and stability required in the design of system.

# Position Estimation

- Using time of flight as a way to measure distance
- The distance is

$$d = \frac{c \times \Delta t}{2}$$

- Given speed of light  $\approx 3 \times 10^8 \frac{m}{s}$
- Flight times might be 30-100 ms, but differences of 3 meters would be on the order of 20 ns, which is a challenge but not impossible

# Outline

- 1 Introduction
- 2 Position Estimation
- 3 System Overview
- 4 Space Segment
- 5 Control Segment
- 6 User Segment
- 7 Augmentation
- 8 GPS Data
- 9 WGS
- 10 Summary

# GPS Overview

- System design based on observation of doppler from Sputnik
- First navigation systems launched around 1962
- Space clocks led the way to GPS
- First satellite launched for GPS around 1978
- Initial capability by Dec 1993
- First complete constellation Feb 14, 1994
- Dual use recognized by 1996

# GPS Structure

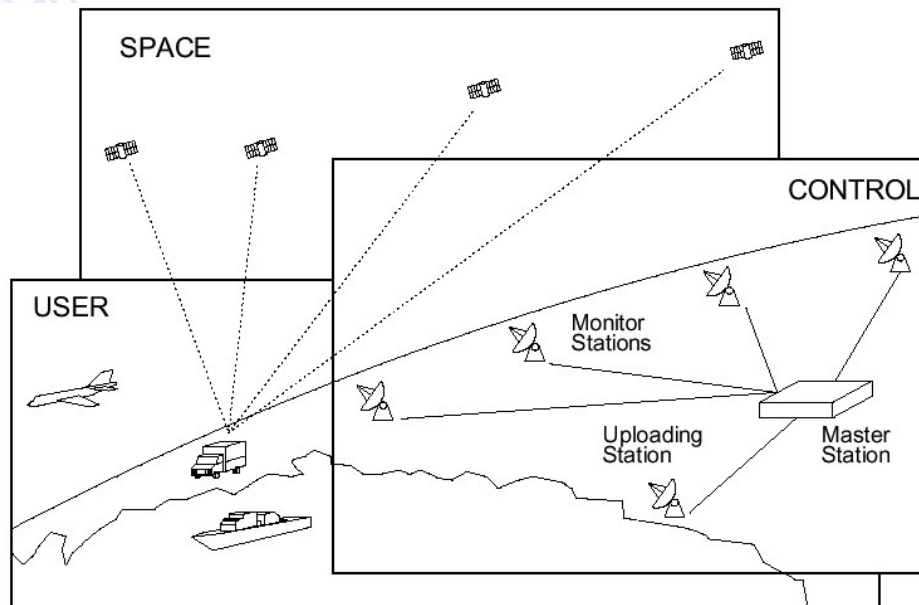

Figure 3.4: The Navstar *Global Positioning System* consists of three fundamental segments: Space, Control, and User. (Adapted from [Getting, 1993].)

# Outline

- 1 Introduction
- 2 Position Estimation
- 3 System Overview
- 4 Space Segment
- 5 Control Segment
- 6 User Segment
- 7 Augmentation
- 8 GPS Data
- 9 WGS
- 10 Summary

# Space Segment



- Composed of 30+ satellites
- Flying at 20,200 km altitude
- In 6 orbital planes
- Nominally 4 satellites in each plane
- Planes have an inclination of  $55^\circ$  wrt Earth

# Satellites

- 5 different types of satellites are in use
- Weight of a satellites in orbit 1080 kg
- Two different signals are transmitted continuously
- Data rate is 50bits/s
- In addition C/A and P(Y) codes are transmitted at  $1.023 * 10^6$  chips/sec.



# Outline

- 1 Introduction
- 2 Position Estimation
- 3 System Overview
- 4 Space Segment
- 5 Control Segment
- 6 User Segment
- 7 Augmentation
- 8 GPS Data
- 9 WGS
- 10 Summary

# Control Segment

- Control segment is responsible for health monitoring
- Correction of space trajectories
- Adjustment of clocks (2ns / year)
- Responsible for uploads
- Monitoring through 5 ground stations
- Managed by 50th Space Wing / 2nd Space Command / Schriever Air Force Base

# Outline

- 1 Introduction
- 2 Position Estimation
- 3 System Overview
- 4 Space Segment
- 5 Control Segment
- 6 User Segment
- 7 Augmentation
- 8 GPS Data
- 9 WGS
- 10 Summary

## User Segment

- The receivers used by users of all kinds
- An antenna, a multi-channel receiver and a fairly accurate clock
- In many cases GPS receivers have an embedded navigation model
- Some GPS units have direct interface to an IMU to allow operation in the presence of partial occlusion or structural noise
- Many receivers communicate in a proprietary format and in addition in NMEA-183 (and some in NMEA 2000) over a serial line (default 4800 baud 8-N-1)

## Navigation Information

- Satellites transmit a navigation message at 50bits/s
- The message is 1500 bits long (30 seconds)
  - 300 bits - clock, delta, GPS time, health, ...
  - 1200 bits - trajectory/orbit data / almanac
- Trajectories are updated each 2 hour
- All times are reported in UTC

# Navigation Codes



- C/A Course/Acquisition Code - Allow early detection of position of satellite based on almanac
- P(Y) Precise / encrypted code - used primarily by military users  
Information sent across 1575.42 and 1227.60 MHz frequencies

# Accuracy

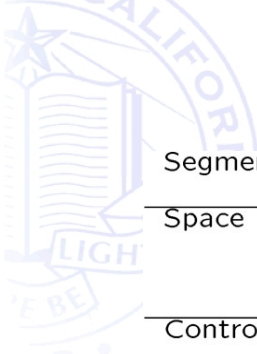

**Table 3.4:** Summary of achievable position accuracies for various implementations of GPS.

GPS Implementation Method	Position Accuracy
C/A-code stand alone	100 m SEP (328 ft)
Y-code stand alone	16 m SEP (52 ft)
Differential (C/A-code)	3 m SEP (10 ft)
Differential (Y-code)	unknown (TBD)
Phase differential (codeless)	1 cm SEP (0.4 in)



# GPS Error Budget



Segment	Error Source	GPS w. SA [m]	GPS wo SA [m]
Space	Satellite clock stability	3.0	3.0
	Satellite perturbations	1.0	1.0
	Selective availability	32.3	-
	Other (thermal, ...)	0.5	0.5
Control	Ephemeris pred. error	4.2	4.2
	Other (truster perf., ...)	0.9	0.9
User	Ionospheric delay	5.0	5.0
	Tropospheric delay	1.5	1.5
	Receiver noise	1.5	1.5
	Multipath	2.5	2.5
	Other	0.5	0.5
System	Total (RMS)	33.3	8.0

SA turned off May 2, 2000 by executive order.

## Outline

- 
- 1 Introduction
  - 2 Position Estimation
  - 3 System Overview
  - 4 Space Segment
  - 5 Control Segment
  - 6 User Segment
  - 7 Augmentation
  - 8 GPS Data
  - 9 WGS
  - 10 Summary

# Augmentation Methods

- Augmentation methods designed to reduce errors and produce better accuracy estimates
- Most frequently used methods
  - 1 Differential GPS (dGPS)
  - 2 Wide-Area Augmentation Services (WAAS)
  - 3 Inertial Navigation System (INS)
  - 4 Assisted GPS (A-GPS)

# Differential GPS

- Uses fixed landmarks and local differentials to correct for errors
- Initially introduced to compensate for SA
- Possible options include
  - Local Radio Beacon
  - US Coast Guard Stations (Maritime Differential GPS)
  - National Differential GPS (NDPS)
    - Close to 80 stations in operations, goal is 128
  - Differential networks also in place throughout Canada and Europe
  - Most stations transmit in the region close to 300 KHz

# Differential GPS Sketch

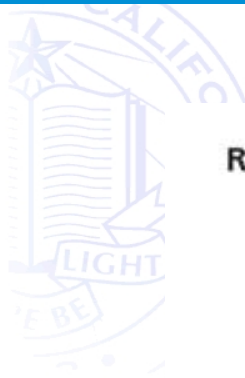

## Real-Time Differential GPS

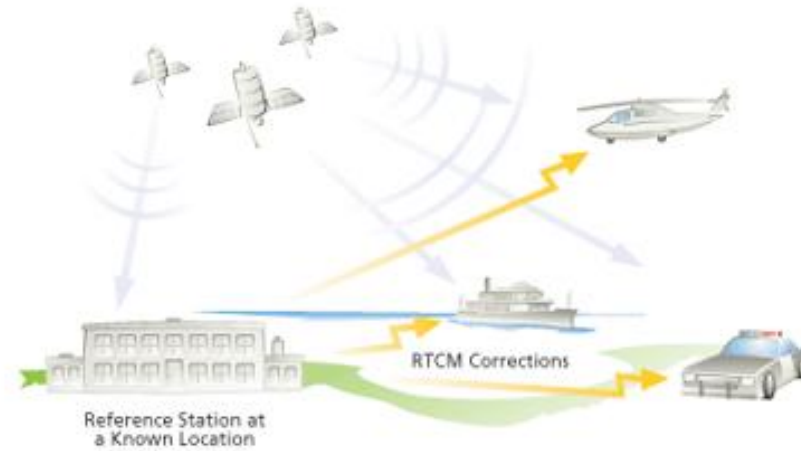

# dGPS Error Budget

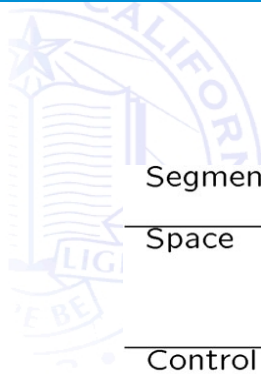

Segment	Error Source	GPS w. SA [m]	LADGPS [m]
Space	Satellite clock stability	3.0	0.0
	Satellite perturbations	1.0	0.0
	Selective availability	32.3	0.0
	Other (thermal, ...)	0.5	0.0
Control	Ephemeris pred. error	4.2	0.0
	Other (truster perf., ...)	0.9	0.0
User	Ionospheric delay	5.0	0.0
	Tropospheric delay	1.5	0.0
	Receiver noise	1.5	2.1
	Multipath	2.5	2.5
	Other	0.5	0.5
System	Total (RMS)	33.3	3.3

# Wide Area Augmentation Service (WAAS)

- System developed by FAA for increased GPS accuracy
- Objective is an increase in accuracy of 5 times
- WAAS corrections are distributed by satellites (IDs 35-51)
- Uses 25 Ground Stations
- Objective GDOP < 7m

## WAAS

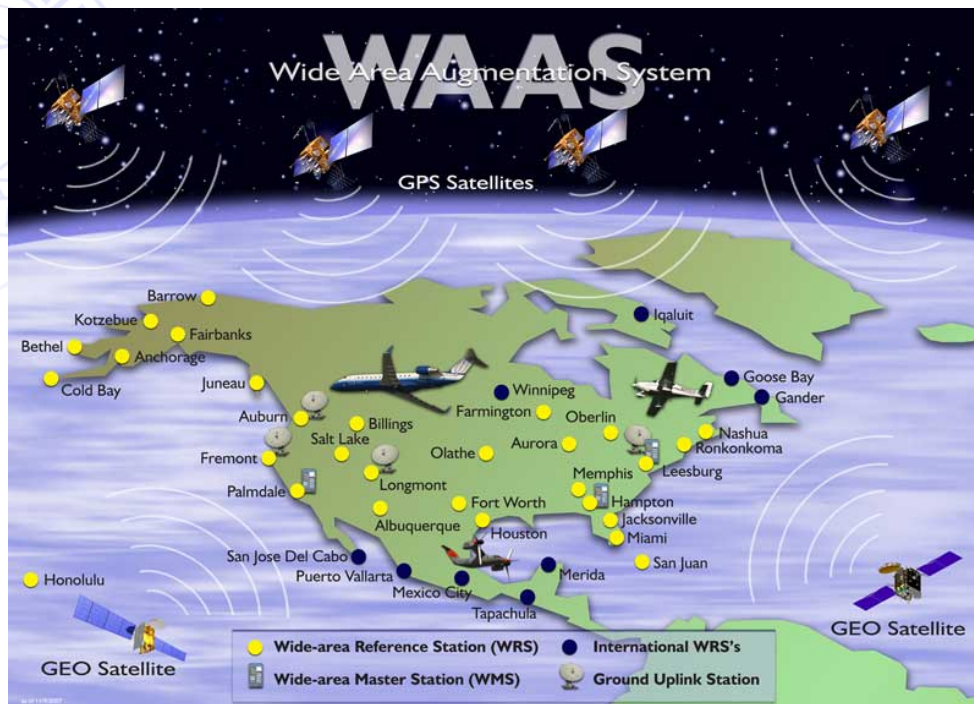

# Assisted GPS

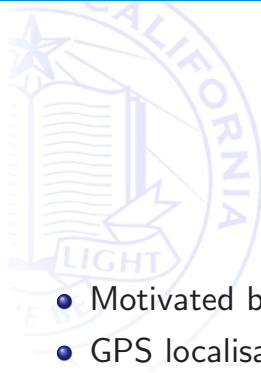

- Motivated by Cell Phone 911 usage
- GPS localisation and Base Station Triangulation
- Only useful for cell phones w. GPS and GPRS/3G

# Phone Localization! (wo. GPS)

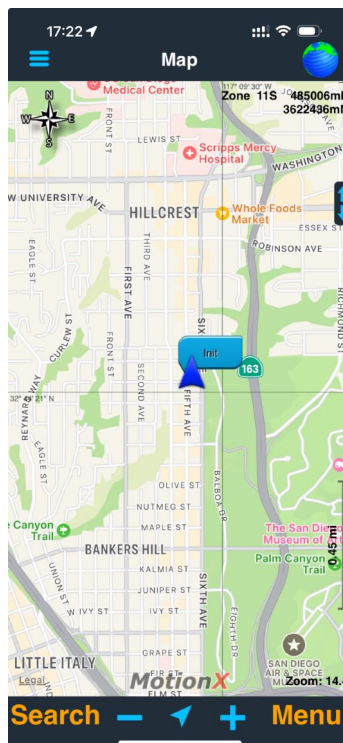

# Outline

- 1 Introduction
- 2 Position Estimation
- 3 System Overview
- 4 Space Segment
- 5 Control Segment
- 6 User Segment
- 7 Augmentation
- 8 GPS Data
- 9 WGS
- 10 Summary

# NMEA - Data

- NMEA - 0183 Standard
- Combined serial / electrical standard
- ASCII protocol for transmission
- Originally for marine electronics
- RS-232/RS-485/.. serial communication
- Most GPS Units today have a USB / Serial connection

# NMEA



- Defined as “sentences”
- Sentences start with a \$ and end with cr/lf
- Structure  
\$GPcmd,field1,field2,field3hh<cr><lf>

## Typical NMEA commands



- GGA Fix information
- GLL Lat/Lon data
- GSA Overall satellite data
- GRS GPS Range Residuals
- GST GPS Pseudorange Noise Statistics

## Example NMEA Data

\$GPGGA,123519,4807.038,N,01131.000,E,1,08,0.9,545.4,M,46.9,M,,\*47

**GGA** Global Position Fix Data

**123519** Data acquired 12:35:19 UTC

**4807.038,N** Latitude 48 deg 07.038' N

**01131.000,E** Longitude 11 deg 31.000' E

**1** Fix Quality (0=invalid .. 2=dGPS)

**08** #satellites tracked

**0.9** HDOP

**545.4,M** Altitude in m above sea level

**46.9.m** Height above WGS-84 ellipsoid

**empty** Time since dGPS update

**empty** dGPS station ID

**\*47** Checksum of message

## Outline

- 1 Introduction
- 2 Position Estimation
- 3 System Overview
- 4 Space Segment
- 5 Control Segment
- 6 User Segment
- 7 Augmentation
- 8 GPS Data
- 9 WGS
- 10 Summary



# World Geodetic System (WGS)

- Defines a reference frame for the earth
- Derived from an elliptical model of earth
- Required to perform accurate surveying
- Ellipsoid (WGS-84)

Semi-major axis 6,378,137 m

Semi-minor axis 6,356,752.314245 m

Inverse flattening 298.257223563

# GPS Models

- LAT/LONG - position on the globe
- UTM - Universal Traverse Mercator
- Local grids adopted to particular regions are common
  - Most GPS units have at least 30 different models
  - Careful selection is important

# UTM coordinate frame

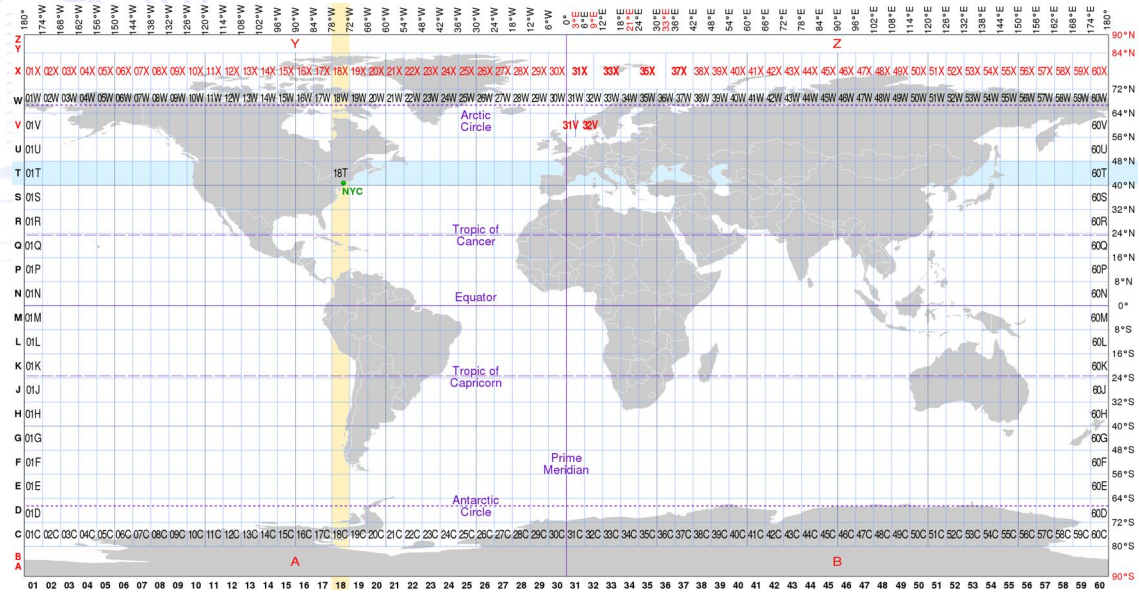

## Outline

- 1 Introduction
- 2 Position Estimation
- 3 System Overview
- 4 Space Segment
- 5 Control Segment
- 6 User Segment
- 7 Augmentation
- 8 GPS Data
- 9 WGS
- 10 Summary

# Summary

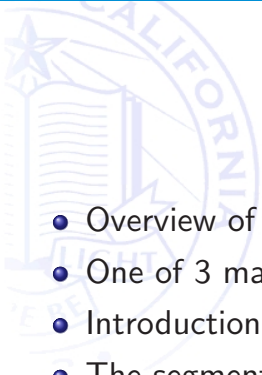

- Overview of GPS system
- One of 3 major GNSS systems
- Introduction to the basic principle
- The segmentation of the system
- Typical error sources
- Strategies to compensate for errors
- Data formats and reference models